



Cambridge International Examinations
Cambridge International General Certificate of Secondary Education

PHYSICAL SCIENCE

0652/11

Paper 1 Multiple Choice

October/November 2016

45 minutes

Additional Materials: Multiple Choice Answer Sheet
Soft clean eraser
Soft pencil (type B or HB is recommended)



READ THESE INSTRUCTIONS FIRST

Write in soft pencil.

Do not use staples, paper clips, glue or correction fluid.

Write your name, Centre number and candidate number on the Answer Sheet in the spaces provided unless this has been done for you.

DO NOT WRITE IN ANY BARCODES.

There are **forty** questions on this paper. Answer **all** questions. For each question there are four possible answers **A, B, C** and **D**.

Choose the **one** you consider correct and record your choice in **soft pencil** on the separate Answer Sheet.

Read the instructions on the Answer Sheet very carefully.

Each correct answer will score one mark. A mark will not be deducted for a wrong answer.

Any rough working should be done in this booklet.

A copy of the Periodic Table is printed on page 16.

Electronic calculators may be used.

This document consists of **16** printed pages.

1 In which process is heat energy neither given out nor taken in?

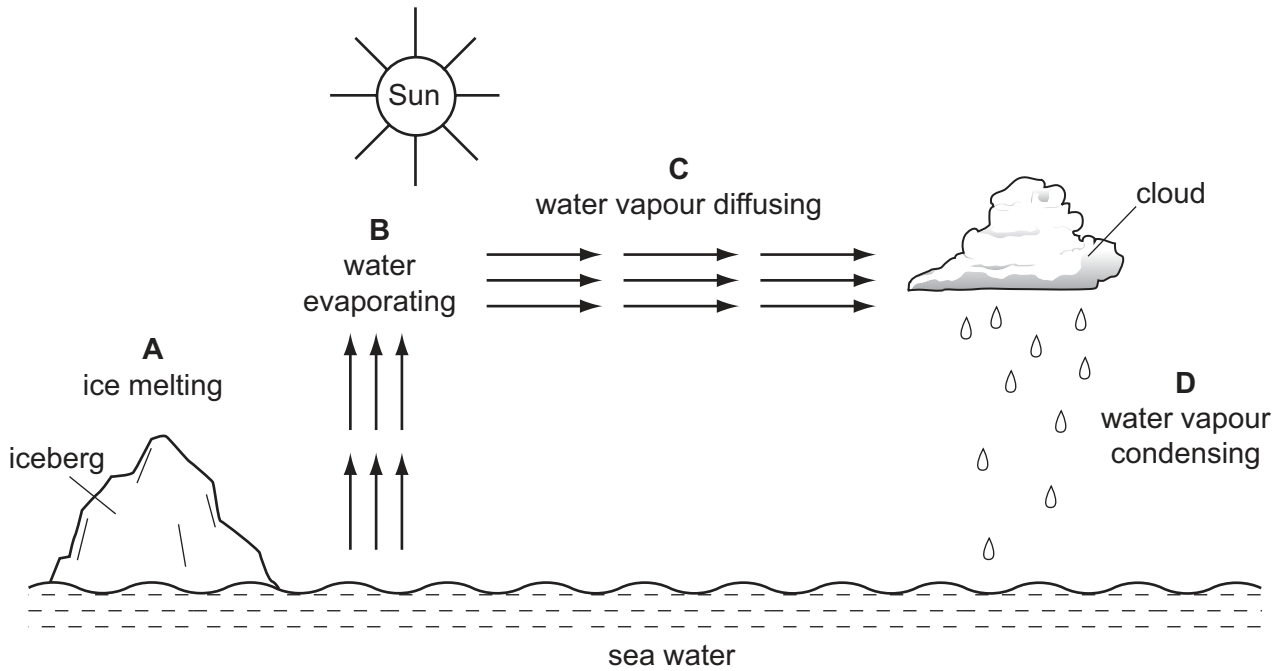

2 The chromatogram of black ink and three coloured dyes, X, Y and Z, is shown.

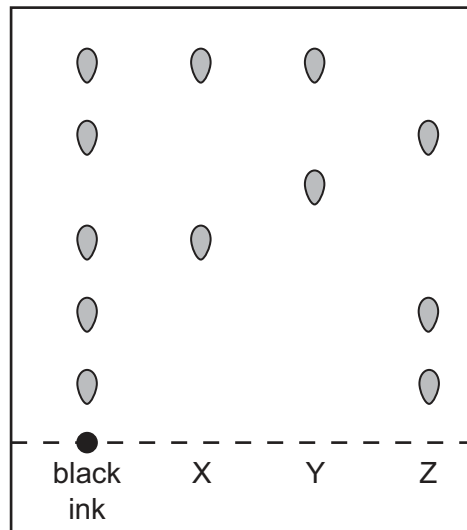

Which colours make up the black ink?

- A** X and Y only
- B** X and Z only
- C** X, Y and Z
- D** Z only

- 3 A bottle of a solid is labelled as shown.

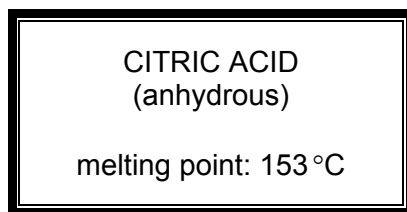

The melting point of a sample from the bottle is measured.

The sample melts over a temperature range from 140 °C to 150 °C.

Which statement explains this observation?

- A The sample contains a mixture of citric acid and other solids.
 - B The sample is too large.
 - C The sample has a pH less than 7.
 - D The sample is too small.
- 4 A new element was officially named as flerovium at the end of May 2012.

An atom of flerovium is represented by the symbol ${}_{114}^{289}\text{Fl}$.

Which statement about the atom of flerovium is correct?

- A It contains 114 electrons and 175 nucleons.
 - B It contains 114 electrons and 289 protons.
 - C It contains 114 neutrons and 175 protons.
 - D It contains 114 protons and 289 nucleons.
- 5 Which statement about the structure of diamond is correct?
- A Each atom has three covalent bonds.
 - B Electrons in the structure are free to move.
 - C It is made up of layers of atoms.
 - D It is tetrahedral.
- 6 X is a compound that contains the elements potassium, manganese and oxygen.

X has twice as many potassium atoms as manganese atoms and twice as many oxygen atoms as potassium atoms.

What is the formula of X?

- A KMnO_2 B K_2MnO_2 C K_2MnO_4 D KMn_2O_4

- 7 What is the relative formula mass, M_r , of lead nitrate, $\text{Pb}(\text{NO}_3)_2$?
- A 237 B 269 C 317 D 331
- 8 Which statement about all exothermic reactions is correct?
- A They absorb heat energy.
 B They produce flames.
 C They release heat energy.
 D They require oxygen gas.
- 9 Hydrogen is passed over a heated metal oxide as shown.

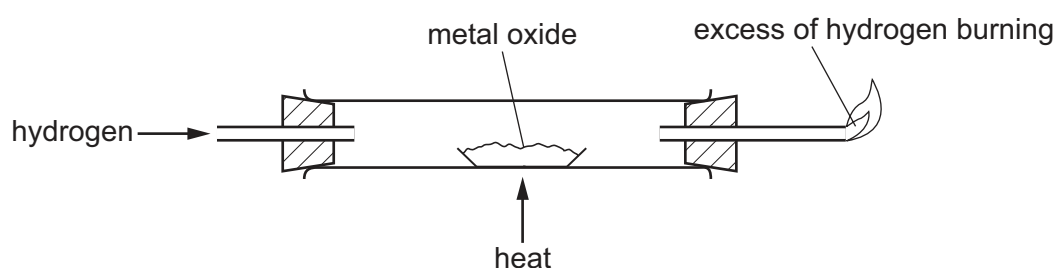

The metal and steam are formed.

What happens to the hydrogen and to the metal oxide?

	hydrogen	metal oxide
A	oxidised	oxidised
B	oxidised	reduced
C	reduced	oxidised
D	reduced	reduced

- 10 Which gas is produced when sodium carbonate reacts with hydrochloric acid?
- A carbon dioxide
 B chlorine
 C hydrogen
 D oxygen

14 Which statement about metals or non-metals is correct?

- A Metals are poor conductors of heat.
- B Most metals have low melting points.
- C Most non-metals are poor conductors of electricity.
- D Non-metals are malleable.

15 Zinc is a metal which has many uses.

When zinc is mixed with copper it forms1..... which is an2..... .

Zinc is also used in the process of3..... to protect iron.

Which words correctly complete gaps 1, 2 and 3?

	1	2	3
A	brass	alkali	rusting
B	brass	alloy	galvanising
C	brass	alloy	rusting
D	steel	alloy	galvanising

16 Hydrated copper(II) sulfate is heated.

Which type of reaction takes place and what is the colour of the product?

	type of reaction	colour of product
A	irreversible	blue
B	irreversible	white
C	reversible	blue
D	reversible	white

17 Which reaction describes how lime is made from limestone?

- A adding limestone to calcium hydroxide
- B adding water to limestone
- C heating limestone
- D heating limestone and dilute sulfuric acid

18 Which statement explains why the members of a homologous series have similar chemical properties?

- A They have the same functional group.
- B They have the same number of carbon atoms.
- C They have the same number of electrons.
- D They have the same types of atom.

19 Which statements about the alkanes are correct?

- 1 Their boiling point increases as the number of carbon atoms increases.
- 2 They burn in air to produce carbon dioxide and water.
- 3 They contain carbon to carbon double bonds.
- 4 They decolourise bromine water.

- A 1, 2 and 3 B 1 and 2 C 1, 3 and 4 D 2 and 4

20 What is **not** a use of ethanol?

- A as a solvent
- B making ethane
- C making alcoholic drinks
- D producing heat energy

21 The diagram shows two identical spheres placed beside a scale.

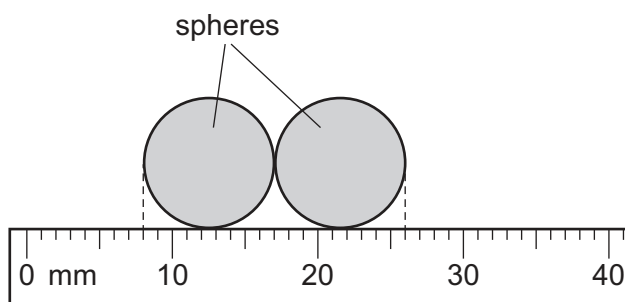

What is the radius of one sphere?

- A 4.5 mm B 6.5 mm C 9.0 mm D 13.0 mm

22 A stone is dropped from the top of a building. It falls until it hits the ground.

Which graph shows how the speed of the stone changes with time?

Ignore air resistance.

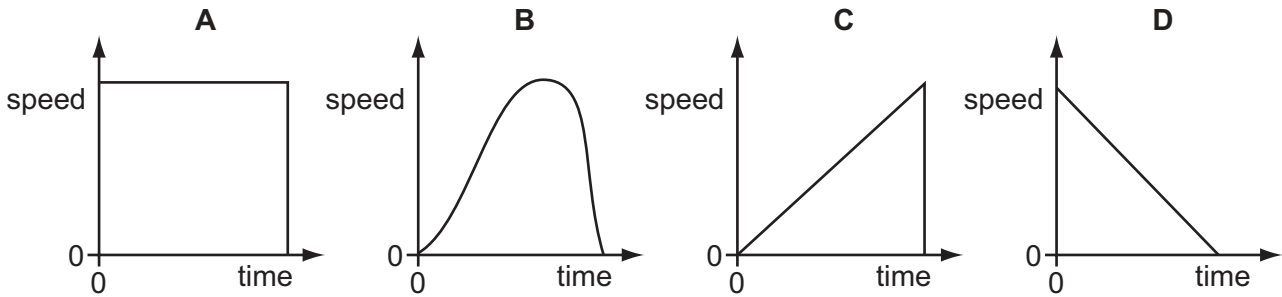

23 Three properties of a gas are its mass, its volume and its density.

Which of these properties can be changed by a force?

	mass	volume	density
A	✓	✓	✓
B	✓	✗	✗
C	✗	✓	✓
D	✗	✓	✗

key

✓ = can be changed

✗ = cannot be changed

24 A student needs to find the density of a large cubic block of wood.

Which two pieces of apparatus should she use?

- A** balance and metre rule
- B** balance and thermometer
- C** measuring cylinder and metre rule
- D** measuring cylinder and thermometer

25 The diagrams show a steel spring and a graph of its length against the load applied to it.

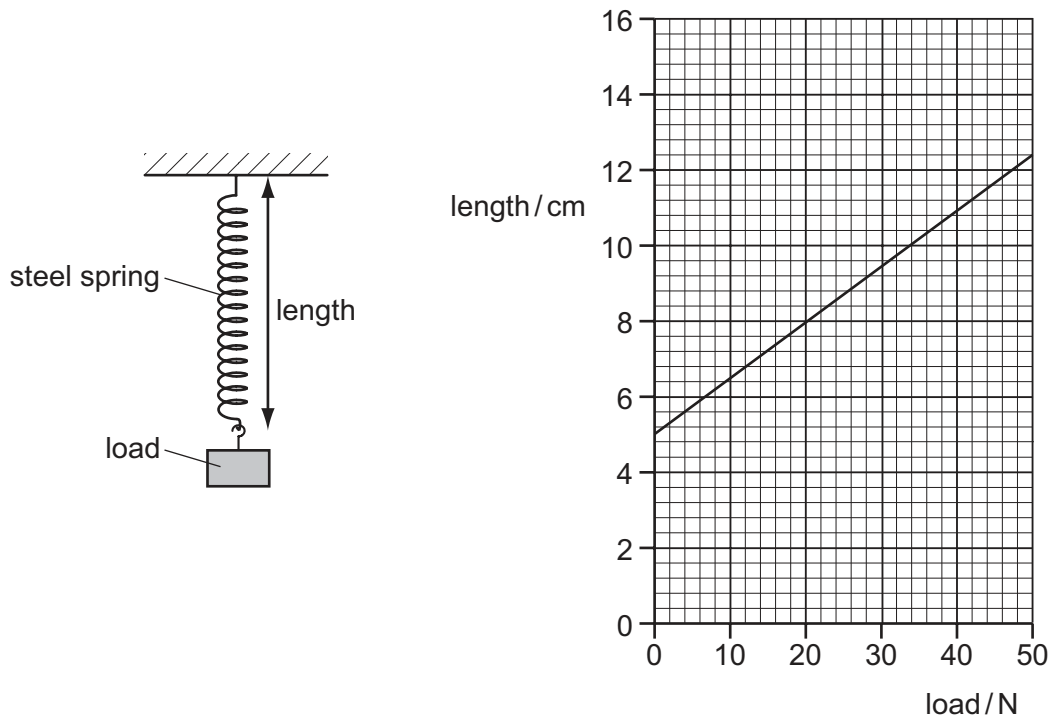

What is the extension of the spring when a load of 20 N is applied to it?

- A 3.0 cm B 4.5 cm C 5.0 cm D 8.0 cm

26 A toy car without a motor is pushed, then follows the looped track shown.

At which labelled point on the track is the energy of motion (kinetic energy) of the car decreasing and the energy of position (gravitational energy) increasing?

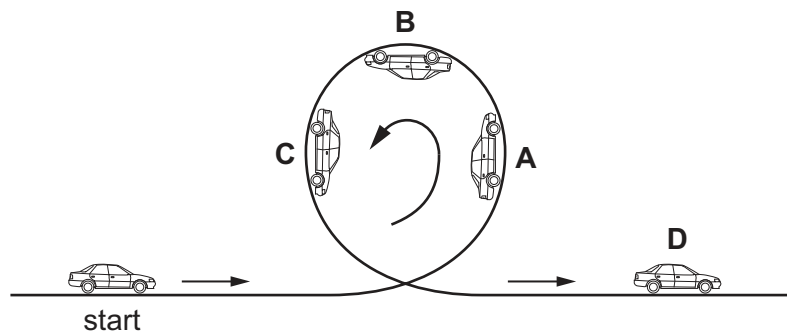

- 27 A liquid-in-glass thermometer can measure temperatures between -20°C and 120°C . The diagram shows the thermometer placed in water at 60°C .

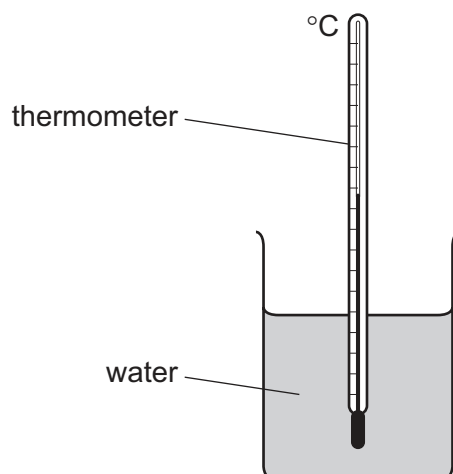

Which temperature is a fixed point on the scale of the thermometer?

- A -20°C B 60°C C 100°C D 120°C
- 28 An air-cooling unit is fitted halfway up the wall of a room. The unit changes the density of the air in the room near it which causes the air to move.

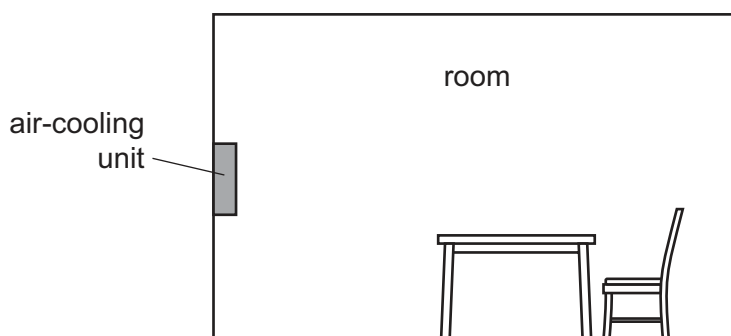

In which way does the cooling unit change the density of the air, and in which direction does the air move?

	change to the density of the air	direction of air movement
A	decreases	downwards
B	decreases	upwards
C	increases	downwards
D	increases	upwards

- 29 The diagrams represent water waves in a deep pond. The diagrams are all drawn to the same scale.

Which diagram shows the wave with the highest frequency?

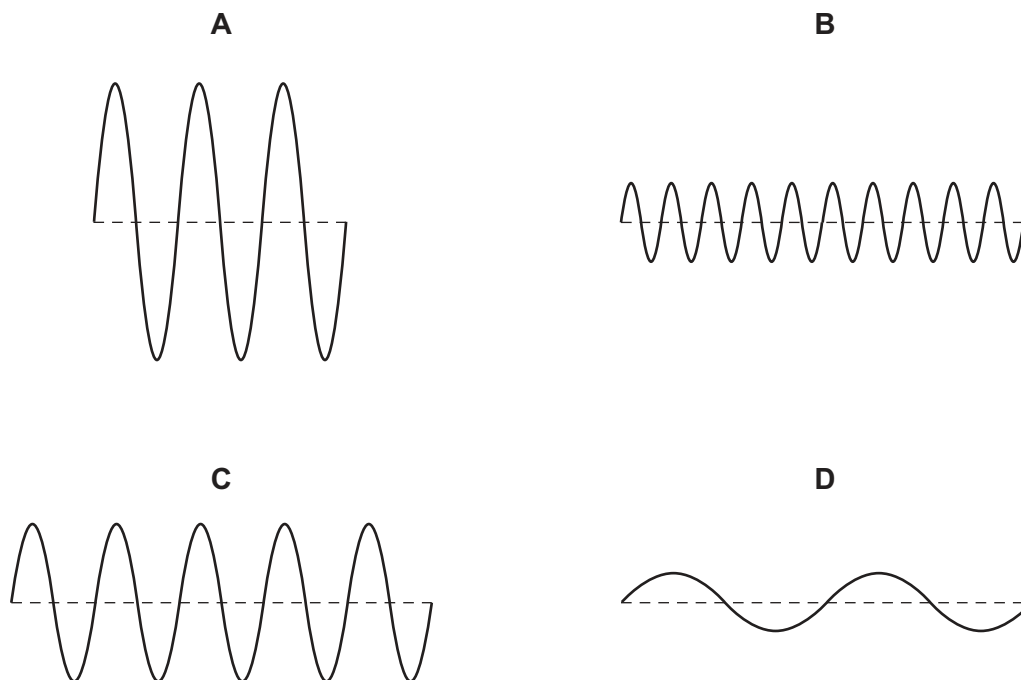

- 30 The diagram shows an object in front of a plane mirror. A ray of light from the object strikes the mirror and is reflected. Two positions P and Q are labelled, and two arrows R and S are labelled.

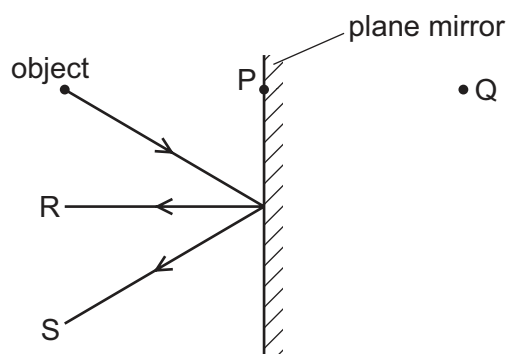

Which row shows the position of the image formed and the reflected ray?

	position of image	the reflected ray
A	P	R
B	P	S
C	Q	R
D	Q	S

- 31 Radio waves and light waves travel *in vacuo* (in a vacuum).

How do the frequency and the speed of the radio waves compare with the frequency and speed of the light waves?

	frequency of radio waves	speed of radio waves
A	greater than light	greater than light
B	greater than light	the same as light
C	less than light	greater than light
D	less than light	the same as light

- 32 Three loudspeakers vibrate at different frequencies of 5 hertz, 25 kilohertz and 50 kilohertz.

Which row shows whether the vibrations from each loudspeaker can be heard by a human?

	5 hertz	25 kilohertz	50 kilohertz
A	no	no	no
B	no	yes	no
C	yes	no	yes
D	yes	yes	yes

- 33 The north pole of a bar magnet is placed next to end P of an iron bar PQ, as shown. As a result, magnetic poles are induced in the iron bar.

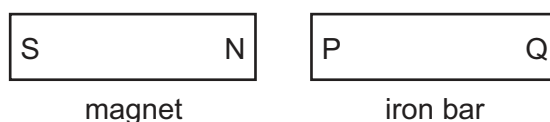

What are the magnetic poles induced at P and at Q?

	magnetic pole at P	magnetic pole at Q
A	north	north
B	north	south
C	south	north
D	south	south

- 34** Three charged plastic balls, P, Q and R are suspended by insulating threads. Ball P is positively charged.

Diagram 1 shows what happens when ball Q is brought close to ball P.

Diagram 2 shows what happens when ball Q is brought close to ball R.

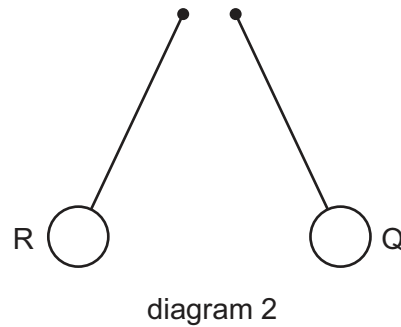
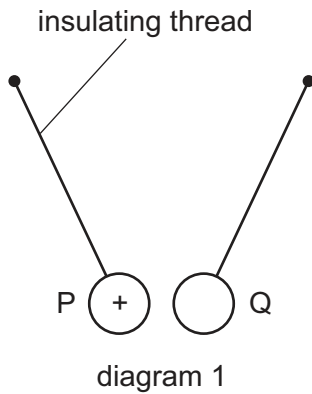

What are the charges on ball Q and ball R?

	charge on ball Q	charge on ball R
A	negative	negative
B	negative	positive
C	positive	negative
D	positive	positive

- 35** Which two quantities are both measured in volts?

- A** current, potential difference
- B** current, resistance
- C** electromotive force, resistance
- D** electromotive force, potential difference

36 A student investigates how the current in a resistor R varies with the voltage across it.

Which circuit is suitable for the student to use?

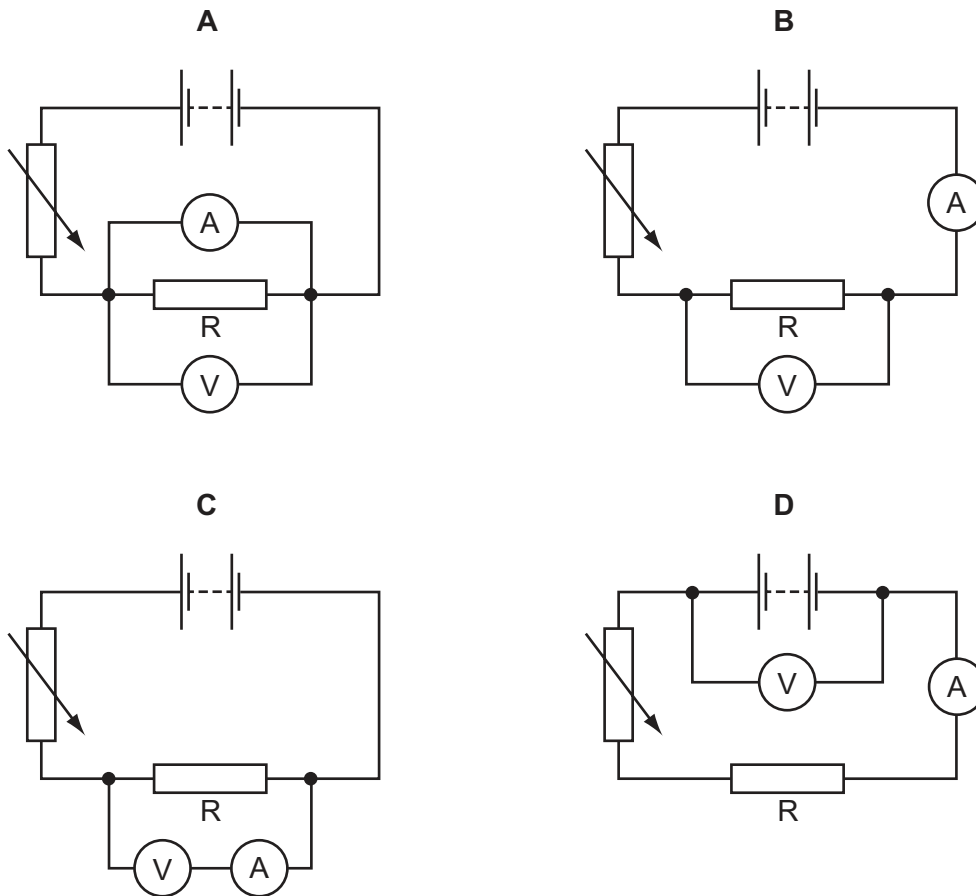

37 Overheating of a cable in an electric circuit is a safety hazard.

How can overheating of a circuit be prevented?

- A Do not switch off the circuit with damp hands.
- B Make sure that the current does not become too large.
- C Use thicker insulation on the wires in the circuit.
- D Use thinner wires in the circuit.

38 The diagram shows a cathode-ray tube.

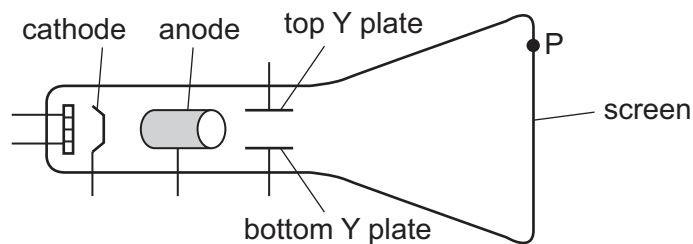

A student wants the cathode rays to make a spot at P on the screen.

Which parts of the cathode-ray tube should be positive?

- A anode and top Y plate
- B anode and bottom Y plate
- C cathode and top Y plate
- D cathode and bottom Y plate

39 Radiation from a radioactive source passes through thick paper into a magnetic field. Some of this radiation is deflected by the magnetic field and some is not deflected.

Which radiation enters the magnetic field?

- A alpha-particles, beta-particles and gamma-rays
- B beta-particles and gamma-rays only
- C beta-particles only
- D gamma-rays only

40 A carbon-14 nucleus is represented by ${}^{14}_6\text{C}$.

Which statement is correct?

- A A nucleus ${}^{14}_7\text{X}$ is an isotope of carbon-14.
- B The carbon-14 nucleus contains 8 neutrons.
- C The carbon-14 nucleus contains 14 positive charges.
- D The nucleon number of the carbon-14 nucleus is 6.

Permission to reproduce items where third-party owned material protected by copyright is included has been sought and cleared where possible. Every reasonable effort has been made by the publisher (UCLES) to trace copyright holders, but if any items requiring clearance have unwittingly been included, the publisher will be pleased to make amends at the earliest possible opportunity.

To avoid the issue of disclosure of answer-related information to candidates, all copyright acknowledgements are reproduced online in the Cambridge International Examinations Copyright Acknowledgements Booklet. This is produced for each series of examinations and is freely available to download at www.cie.org.uk after the live examination series.

Cambridge International Examinations is part of the Cambridge Assessment Group. Cambridge Assessment is the brand name of University of Cambridge Local Examinations Syndicate (UCLES), which is itself a department of the University of Cambridge.

The Periodic Table of Elements

		Group															
I	II	III	IV	V	VI	VII	VIII										
3 Li lithium 7	4 Be beryllium 9	<div style="border: 1px solid black; padding: 5px; text-align: center;"> Key atomic number atomic symbol name relative atomic mass </div>										2 He helium 4					
11 Na sodium 23	12 Mg magnesium 24											5 B boron 11	6 C carbon 12	7 N nitrogen 14	8 O oxygen 16	9 F fluorine 19	10 Ne neon 20
19 K potassium 39	20 Ca calcium 40	21 Sc scandium 45	22 Ti titanium 48	23 V vanadium 51	24 Cr chromium 52	25 Mn manganese 55	26 Fe iron 56	27 Co cobalt 59	28 Ni nickel 59	29 Cu copper 64	30 Zn zinc 65	31 Ga gallium 70	32 Ge germanium 73	33 As arsenic 75	34 Se selenium 79	35 Br bromine 80	36 Kr krypton 84
37 Rb rubidium 85	38 Sr strontium 88	39 Y yttrium 89	40 Zr zirconium 91	41 Nb niobium 93	42 Mo molybdenum 96	43 Tc technetium —	44 Ru ruthenium 101	45 Rh rhodium 103	46 Pd palladium 106	47 Ag silver 108	48 Cd cadmium 112	49 In indium 115	50 Sn tin 119	51 Sb antimony 122	52 Te tellurium 128	53 I iodine 127	54 Xe xenon 131
55 Cs caesium 133	56 Ba barium 137	57–71 lanthanoids	72 Hf hafnium 178	73 Ta tantalum 181	74 W tungsten 184	75 Re rhenium 186	76 Os osmium 190	77 Ir iridium 192	78 Pt platinum 195	79 Au gold 197	80 Hg mercury 201	81 Tl thallium 204	82 Pb lead 207	83 Bi bismuth 209	84 Po polonium —	85 At astatine —	86 Rn radon —
87 Fr francium —	88 Ra radium —	89–103 actinoids	104 Rf rutherfordium —	105 Db dubnium —	106 Sg seaborgium —	107 Bh bohrium —	108 Hs hassium —	109 Mt meitnerium —	110 Ds darmstadtium —	111 Rg roentgenium —	112 Cn copernicium —	114 Fl flerovium —	116 Lv livermorium —	—	—	—	—

lanthanoids	57 La lanthanum 139	58 Ce cerium 140	59 Pr praseodymium 141	60 Nd neodymium 144	61 Pm promethium —	62 Sm samarium 150	63 Eu europium 152	64 Gd gadolinium 157	65 Tb terbium 159	66 Dy dysprosium 163	67 Ho holmium 165	68 Er erbium 167	69 Tm thulium 169	70 Yb ytterbium 173	71 Lu lutetium 175
actinoids	89 Ac actinium —	90 Th thorium 232	91 Pa protactinium 231	92 U uranium 238	93 Np neptunium —	94 Pu plutonium —	95 Am americium —	96 Cm curium —	97 Bk berkelium —	98 Cf californium —	99 Es einsteinium —	100 Fm fermium —	101 Md mendelevium —	102 No nobelium —	103 Lr lawrencium —

The volume of one mole of any gas is 24 dm³ at room temperature and pressure (r.t.p.)